

# THE STC-8 DISCRETE CLASS A STEREO COMPRESSOR-PEAK LIMITER



## OPERATOR'S MANUAL

Version 1.2

**CRANE SONG LTD.**

2117 East 5th Street  
Superior, WI 54880 USA  
tel: 715-398-3627  
fax: 715-398-3279  
[www.cranesong.com](http://www.cranesong.com)

## IMPORTANT SAFETY INSTRUCTIONS

1. Read these instructions
2. Keep these instructions
3. Heed all warnings
4. Follow all instructions
5. Do not use this apparatus near water
6. Clean only with dry cloth
7. Install in accordance with the manufacturer's instructions
8. Do not install near any heat sources such as radiators, heat registers, stoves, or other apparatus (including amplifiers) that produce heat
9. Protect the power cord from being walked on or pinched particularly at plugs and the point where they exit from the apparatus
10. Only use attachments/accessories specified by the manufacturer
11. Unplug this apparatus during lightning storms or when unused for long periods of time
12. Refer all servicing to qualified service personnel. Servicing is required when the apparatus has been damaged in any way, such as power-supply cord or plug is damaged, liquid has been spilled or objects have fallen into the apparatus, the apparatus has been exposed to rain or moisture, does not operate normally, or has been dropped
13. CAUTION: To disconnect the unit completely from the MAINS, unplug the unit. Turning the power switch off does not disconnect the unit completely from the MAINS.

# TABLE OF CONTENTS

|   | PAGE |
|---|------|
| INTRODUCTION .....                      | 2    |
| Class A .....                           | 2    |
| Heating and Warm-up .....               | 2    |
| PANEL REFERENCE .....                   | 3    |
| CONTROL DESCRIPTION .....               | 4    |
| Preset Switch Layout .....              | 5    |
| Input/Output GR Graphs .....            | 7    |
| DISTORTION AND COMPRESSORS .....        | 8    |
| COMPRESSOR QUICK GUIDE .....            | 9    |
| The "V" Setting .....                   | 9    |
| Preset Settings .....                   | 10   |
| FAST SET-UP OF THE PEAK LIMITER .....   | 10   |
| COMBINED COMPRESSOR LIMITER .....       | 11   |
| The Attack Modulation Decision .....    | 11   |
| "NUMBERS" .....                         | 11   |
| Presets .....                           | 12   |
| BLOCK DIAGRAM .....                     | 13   |
| INTERFACING .....                       | 14   |
| SPECIFICATIONS .....                    | 15   |
| MODE SWITCH - KI SOUND AND OPTIONS..... | 16   |

## INTRODUCTION

The STC-8 is a high quality compressor combined with a remarkably dependable peak limiter, that provides overload protection critical to digital recording and broadcast transmitters. The STC-8's compressor is engineered to provide musically transparent gain control, but is also capable of emulating vintage equipment and creating distinctive new sounds.

In addition, a switchable enhancement circuit creates "analog" and "tube-like" warmth to enrich lifeless audio and digital recordings. This vast flexibility is simplified by the inclusion of several optimized presets, allowing fast, easy set-up on a wide variety of sounds. It can operate in true stereo or discrete independent mono, accessible by a front panel switch.

The STC-8's sophisticated side-chain allows both compression and peak limiting to take place simultaneously, using the same proprietary gain control circuit. High signal quality is maintained by utilizing a discrete class A audio path, and by eliminating any VCA or optical gain control elements.

The STC-8 requires 2 rack spaces. All inputs and outputs are transformer-less and balanced. The toroidal power transformer is UL approved and allows four line voltages for international use. The STC-8 delivers consistent gain control without sacrificing musical definition or harmonic richness.

## CLASS A DISCRETE TOPOLOGIES

The STC-8 has a Class A audio path which is significantly different than designs that use integrated circuits. Class A circuits sound better because their distortion components tend to be Second Harmonic; musically pleasing. IC Op-Amps do not have class A output circuits and their distortion components tend to be high order odd harmonics; not musical. The most important thing to remember about Class A circuits is that they sound better.

This type of technology has 2 disadvantages when compared to IC designs. 1) Due to the large number of parts in discrete circuits; they are costly. 2) Class A circuits run warm.

## HEATING AND WARM-UP

**The STC-8 must have adequate ventilation.** Make sure the vent holes are not blocked. Do not set anything directly on top of the STC-8. When mounting the STC-8 in a rack, provide as much air flow as possible. Leaving the back of the rack open is another option. If you provide adequate ventilation, you will be rewarded with years of reliable operation.

All precision electronic equipment has an operating temperature that when reached will result in best performance. The STC-8 should be allowed a 10 to 15 minute warm up period before use.

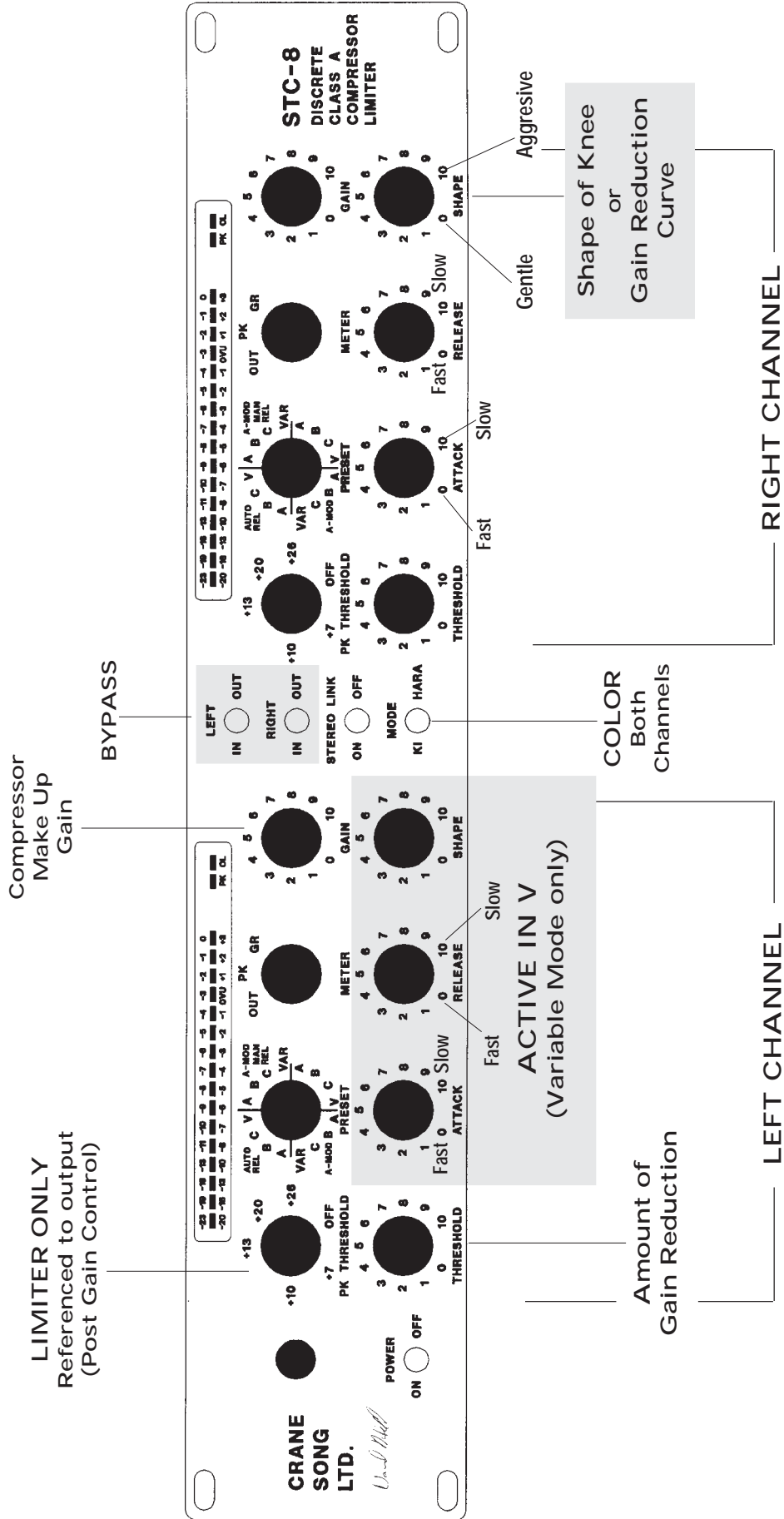

## CONTROL DESCRIPTION

### THRESHOLD

The threshold control governs the amount of gain reduction. The compressor initially has a “soft-knee” compression curve but is increased by the shape control.

### PK THRESHOLD

The peak threshold control sets the level at which the peak limiting takes place. The slope is greater than 10:1 and is fast enough to prevent overload of a transmitter or digital recorder. When a signal's peak is greater than the average gain reduction, the peak circuit will take control until the peak has passed, and then smoothly transfer regulation back to the compressor. The green pk LED will light when the peak circuit is active.

When the **Pk Threshold** Control is set to +20 dBm, the limiter will prevent any increase in output level above that setting. The output will remain constant even if the gain of the STC-8 is increased. **The limiter circuit is post gain control.** The dial calibration relates to the maximum output level.

### GAIN CONTROL

The gain control will adjust the compressor gain from 0 to 14 dB of gain. When in stereo link mode the gain controls operate independently to allow balancing of the stereo program source.

### SIDE CHAIN

The side chain consists of two control circuits, one for peak control and one for compression control. The side chain insert only affects the average or compressor circuits. Due to the design of the stereo link, separate equalizers (with identical settings) must be used for both channels to achieve channel matched operation. This scheme allows reliable signal averaging regardless of the phase relationship between the audio channels. In a conventional stereo link circuit (one EQ for both channels) out of phase material is ignored by the compressor. This is also beneficial for stereo FM broadcast where phase relationships can affect the stereo generator.

### PRESET SWITCH

The preset rotary switch allows fast and predictable set-up of the STC-8. At first glance this knob may look a bit forbidding, but in operation, this switch is the key to the flexibility and foolproof operation of the compressor-limiter.

The STC-8 features two advanced functions: 1) Program Dependent Release (PDR) and 2) Dynamic Attack Modification (A-MOD). The four groups of presets simply give every combination of these settings. Further, each group has three presets with predetermined, optimized attack, release and shape settings and one variable setting (which activates the front panel controls).

In the left half of the settings the Program Dependent Release is enabled. This function is especially well suited for leveling the volume of the audio without bringing up background noise. It is especially helpful controlling voice over, lead vocal and any other complex program material where short release times tend to bring out room noise and headphone leakage. The right half of the switch has constant release times, useful for enhancing the sustain of guitars or room ambience on percussion.

The Dynamic Attack Modification groups are located at the upper right and lower left sections of the preset matrix. With either A-MOD group enabled, the peak limiter will dynamically modify the attack time of the compressor function. When a slower attack time (3 or higher) is selected on the compressor, any signal triggering the peak limiter automatically shortens the attack time of the compressor. This gives the STC-8 the ability to average program when employing long attack times while still maintaining overload protection. More notably, the compressor will quickly control the audio after a period of silence.

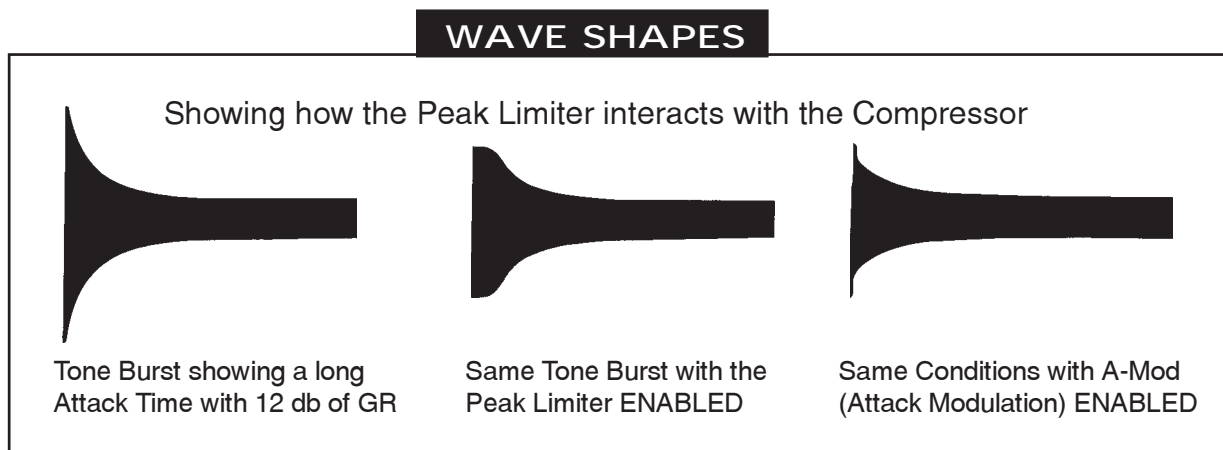
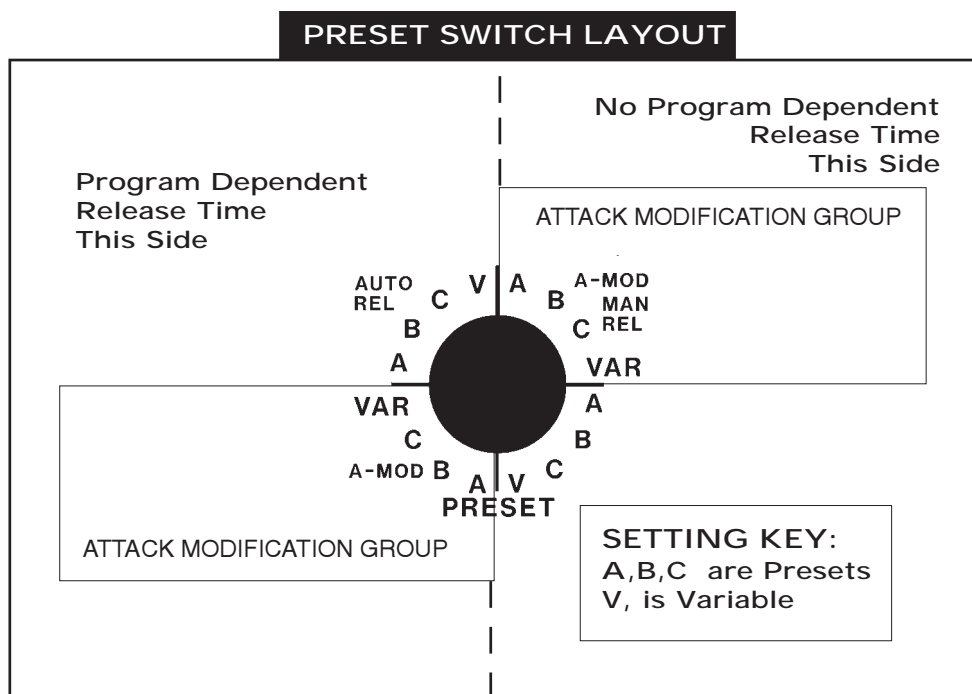

**STEREO LINK SWITCH**

When in the link mode the gain control, bypass switches, and meter switches still operate independently. All other functions are operated by the Channel 1 controls.

**BYPASS SWITCH**

The bypass switch selects the *output signal source*. When the unit is bypassed all of the compressor circuitry is removed from the audio path. However, the compressor-limiter continues to operate in a monitoring mode. The unit defaults to the bypass condition when the power is off.

**ATTACK CONTROL**

The attack control determines the time it takes the compressor to respond to the input signal and have gain reduction take place. Zero on the control is fast; 10 is slow.

**RELEASE CONTROL**

The release control sets the time for the compressor's gain to return to the point of no gain reduction in the absence of program. Zero on the control is fast; 10 is slow.

The attack and release times depend on the shape setting, amount of gain change, settings on the mode and preset switches, and the program material. They all interact and allow the creation of a wide variety of sounds that are not possible with any other gain control device available.

**MODE SWITCH**

The mode switch affects both channels identically. In the HARA position the audio path is transparent. The KI position adds warmth and color and works very well with bass or voice source material. The audio path and the side chain are modified to get this color change and the effect is also dependent on the attack, release, and shape control settings.



**SHAPE CONTROL**

The shape control changes the gain curve, the relationship between amount of gain reduction taking place and the signal level. The input to output ratio changes as a result of this. With the control set to 0 the curve and slope are gentle. With the control set to 10 the curve is more aggressive and the slope is higher.

**INPUT/OUTPUT GAIN RELATIONSHIP GRAPH (Graph 1)**

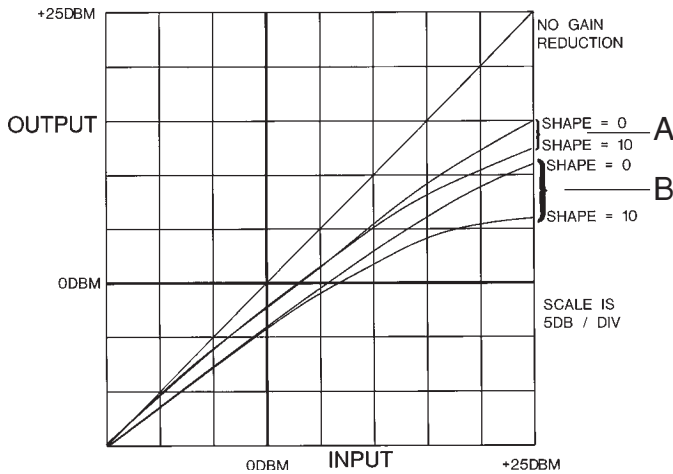

In the graph at left, two groups of curves show gain reduction, groups A and B.

In **group A** with the input at +25dbm and the shape control set at 0, the compressor has an input/output gain relationship that follows the upper curve with 10db of gain reduction at the top of the graph. If the shape control is changed to 10 the STC-8 follows the lower group A curve with 12.5db of gain reduction when the input is at +25dbm.

In **group B** with the input at +25dbm and the shape control set at 0, the compressor has an input/output gain relationship that follows the upper curve with 14db of gain reduction at the top of the graph. If the shape control is changed to 10, the STC-8 follows the lower group B curve with 18db of gain reduction when the input is at +25dbm.

*the top of the graph. If the shape control is changed to 10, the STC-8 follows the lower group B curve with 18db of gain reduction when the input is at +25dbm.*

*The shape control settings will influence the attack and release time because of how the gain relationship changes. In addition to the times, the shape of the attack and release envelopes also change.*

**INPUT/OUTPUT GAIN RELATIONSHIP GRAPH - LIMITER (Graph 2)**

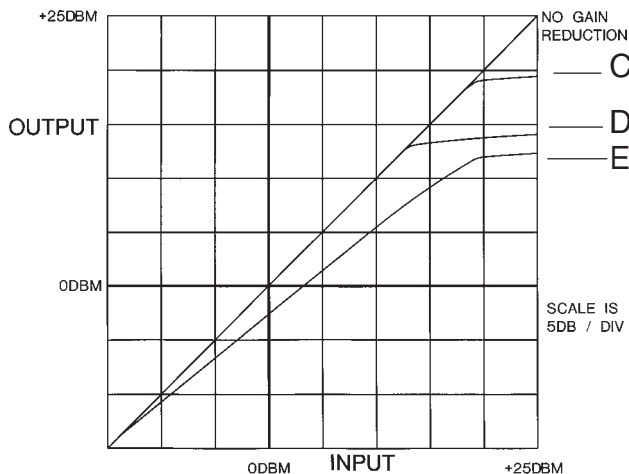

**Graph C** shows the limiter input/output gain relationship with **no** compressor operation. The Pk Threshold is set at +19 dBm. The graph shows a maximum gain reduction of 6db when the input is at +25 dBm.

**Graph D** shows the limiter input/output gain relationship with **no** compressor operation. The Pk Threshold is set at +13 dBm. The graph shows a maximum gain reduction of 11.5db with an input level of +25 dBm.

**Graph E** shows a combined compressor-limiter gain curve. The Pk Threshold is set at +12 dBm. This is the point where the limiter takes over control from the compressor side chain.

*In all three cases there is a slight soft knee when the limiter takes control over gain reduction.*

## METER

The meter has three modes of operation. In the output mode the meter appears as a bar graph. 0 VU is referenced to +4dBm. In the PK mode the meter appears as a dot and shows the amount of head room by showing peak level below clipping. The third mode shows gain reduction. This also appears as a dot type display. The red OL LED lights with clipping in the output stage and the green PK LED lights when the PK side chain takes control from the average side chain. Only the left channel PK LED is operational in stereo link mode. The meter switch selects what is being viewed and the mode that the meter operates in.

## DISTORTION IN COMPRESSORS

Distortion in compressors is dependent on the RELEASE TIME and the RATIO. The higher the ratio or the faster the release time, the greater the amount of induced distortion. This distortion follows the low frequencies and the sound envelope. In all conventional compressors, tube or solid state, this distortion is third harmonic. The distortion is third harmonic because of the way the control circuits and gain control elements function.

Third harmonic distortion is a major part of what are called artifacts. Artifacts influence the sound of the compressor and may or may not be musical. Third harmonic distortion is not a musical artifact.

The STC-8 has the ability to change the type of induced distortion to second harmonic. In doing this the non-musical artifact of third harmonic distortion is changed to the musically pleasing sound of second harmonic distortion. *The STC-8 is the only compressor-limiter on the market that has the ability to change the induced distortion from third harmonic to second.*

Changing the induced distortion from third harmonic to second harmonic results in new and different sounds and adds warmth. This change allows the use of higher compression levels with fast release times and still have the sound remain musical. This function is enabled on the STC-8 by putting the MODE SWITCH in the KI position.

## THE COMPRESSOR "QUICK GUIDE"

To set up the Compressor quickly use the Presets A, B, or C. In these modes the Attack, Release, and Shape controls are **not operational**. Leave the Pk Threshold in the **off** position. With Pk Threshold left in off position, the only decision regarding the Preset Switch is whether or not to use Program Dependent Release (PDR). PDR is the left half of the Preset Switch, non-PDR is the right half. (See Preset Switch layout, page 5)

PDR can be thought of as Auto Release. The Threshold control governs the amount of gain reduction.

### CHOOSING PRESET A, B, OR C

- A** was designed for Vocal sound.
- B** was designed for Bass or to make the attack of a sound "Punch".
- C** was designed for Program Averaging or Volume Control.

Deciding whether or not to use PDR is **easy**. Do you want to bring up the "soft" sounds between words or notes when compressing a voice-like sound (eg. mouth noise, finger noises on an acoustic guitar)? There are times you will want to bring out these sounds; there are times when you won't. Using PDR these sounds will remain quiet in volume (depending on release time). When not using PDR, the in-between sounds will be increased in volume by a greater amount.

PDR is very useful in level or volume control applications. PDR also creates a "softer" sound. It is best to experiment. Some applications work better with PDR, others are better without. The bottom line with PDR is to use your ears to determine what you like.

If you desire a "warmer" sound, try the KI position of the Mode Switch. The amount of effect depends somewhat on the Attack time and mostly on the Release time. Faster settings result in more effect. The KI position is especially useful on voice, bass, horns, and program. KI warms the sound by adding second harmonic and *gives a sound option that is unavailable in any other compressor-limiter*. KI is most effective in Presets A, B and Variable Mode. It is less effective in the C Preset.

### THE "V" SETTING

In the Variable Setting the Attack, Release, and Shape controls are active. They are not active in the A, B, or C Preset Settings.

The shape control changes the gain reduction curve. The higher the setting, the more aggressive the compressor becomes, the higher the ratios become (see graphs 1 & 2 on page 7). If you think of the GR curve as the knee shape, you can think of the shape control as a way to change the shape of the knee.

Table A below shows the relationship between the A, B, and C Presets and the Variable settings. This is useful information when starting with a preset and then wanting to fine tune for a particular sound.

| APPROXIMATE PRESET SETTINGS AND THEIR RELATIONSHIP TO THE VARIABLE MODE |        |         |       |
|---|--------|---------|-------|
| Preset  | Attack | Release | Shape |
| A   | 2      | 5.5     | 3.5   |
| B   | 6.5    | 6       | 1     |
| C   | 6.25   | 7       | 5     |

Table A

**\*NOTE** It is important to note that the Gain Reduction curve , as determined by the shape control, modifies the attack and release times.

## FAST SET-UP OF THE LIMITER

To prevent overload of the following device:

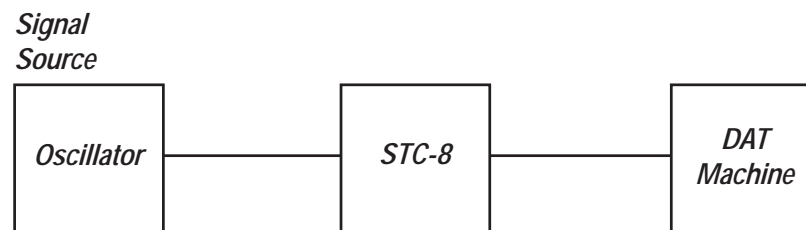

Adjust the *Oscillator* to +16 dBm or more. Adjust the Pk Threshold on the STC-8 for 12db of gain reduction. Use this as the maximum output from the STC-8. Then adjust the input level on the DAT Machine to a point just below overload on the DAT Machine. Leave a safety margin of about 1/4db if you can. The ratio gets greater than 10 to 1 but is not infinite.

If you find that you need more make up gain when using the compressor, you can adjust the STC-8 gain controls and the DAT will still be overload protected. If you increase the input gain on the DAT Machine you will no longer have overload protection.

Increasing the gain controls on the STC-8 will increase the ratio of the limiter, but not affect the compressor. If you find that you have too much Pk Limiting going on, you have 3 options to deal with the situation;

- (1) reduce the amount of make up gain on the STC-8. Reducing the make up gain will not affect compressor operation.
- (2) increase the amount of compression that is taking place, or
- (3) reduce the input level.

Any of these changes will allow you to remain overload protected.

The more you know about your gain structure, where the overload point is, and what your average signal level is, the easier it will be to get maximum level without overloading your digital machine.

## COMBINED COMPRESSOR-LIMITER

When the limiter is set to operate with the compressor, the green peak LED will light when the limiter takes control. It is recommended that the limiter be used in conjunction with the compressor.

### THE ATTACK MODULATION DECISION

Attack modulation (A-Mod) is in the upper right corner and lower left corner on the preset switch (see Preset Switch layout, page 5). Using A-Mod will help prevent the chopped off limited type of sound that occurs when a source is peak limited. A-Mod will usually result in a less processed sound.

A-Mod is also useful in program averaging. When using long attack times a volume suck down may occur at the beginning of a song because of the time it takes the compressor to bring gain under control. The A-Mod setting shortens the compressor attack time when the peak threshold is exceeded. Then it allows the compressor to return to normal operation. By having a shorter attack time at the start of the song, the compressor quickly controls Gain, avoiding the volume suck down.

Light to moderate peak limiting will result in transparent peak limiting when the limiter is used in conjunction with the compressor.

## "NUMBERS"

It is very difficult to assign numbers to Attack Time, Release Time, or Ratio. They change continuously depending on the gain reduction curve and amount of gain reduction taking place. Ratio is defined as:

$$\text{Ratio} = \frac{\text{change in input dB}}{\text{change in output dB}}$$

Amount of gain change can be determined by looking at Graph 1 and Graph 2 on page 7. As evident in the diagrams, the ratio changes at different points on the graph. This change is determined by the amount of gain reduction taking place. The Shape Control changes the gain reduction curve (the shape of the knee). The limiter can also alter that curve. Its like having a second threshold and knee. As a result of this flexibility there are no fixed numbers.

An important point to remember is that as more gain reduction takes place, the ratio becomes higher. The ratio becomes higher when the need to control the sound source becomes greater. By increasing the amount of gain reduction, the louder sound source will automatically cause more gain reduction.

To increase the ratio, i.e. get tighter control, increase the amount of gain reduction taking place. In the variable mode, one can also turn up the shape control. Most tube and optical based compressors work like this.

Don't be afraid to make the STC-8 work. It is happy with 12 dB of gain reduction. Experiment, turn the knobs, find sounds that you like. Numbers are meaningless if the sound is pleasing.

The following chart is an attempt to show what happens with the A, B, and C Presets. For the purpose of the measurements in the chart, the compression range is from no gain reduction to 12 dB of gain reduction. Numbers in the chart are approximate. Ratio conditions are as indicated.

\*Ratio conditions relate to the entire specific preset section, not to Release Time and Conditions columns in the chart. i.e. Starting GR and Ratios in the A Preset section relate to the whole section.

| <b>Preset</b> | <b>Attack Time<br/>to 6db of GR</b> | <b>Release Time<br/>for 6db of Gain<br/>Increase</b> | <b>Conditions</b>                        | <b>Ratio*</b>   |                 |
|---------------|-------------------------------------|--|--|---|-----------------|
|               |                                     |  |  | <i>Measured by incr. input by 3dB<br/>Starting GR</i> | <i>Ratio</i>    |
| <b>A</b>      | <i>2 mS</i>                         | <i>130 mS</i>  | <i>No PDR</i>                            | <i>6 dB</i>   | <i>1.8 to 1</i> |
|               |                                     | <i>78 mS</i>   | <i>PDR signal present<br/>for 128 mS</i> | <i>12 dB</i>  | <i>3 to 1</i>   |
|               |                                     | <i>60 mS</i>   | <i>PDR signal present<br/>for 32 mS</i>  | <i>18 dB</i>  | <i>5 to 1</i>   |
| <b>B</b>      | <i>12 mS</i>                        | <i>110 mS</i>  | <i>No PDR</i>                            | <i>6 dB</i>   | <i>1.9 to 1</i> |
|               |                                     | <i>90 mS</i>   | <i>PDR signal present<br/>for 128 mS</i> | <i>12 dB</i>  | <i>2.7 to 1</i> |
|               |                                     | <i>80 mS</i>   | <i>PDR signal present<br/>for 64 mS</i>  | <i>18 dB</i>  | <i>5.6 to 1</i> |
| <b>C</b>      | <i>10 mS</i>                        | <i>.45 sec</i>                                       | <i>No PDR</i>                            | <i>6 dB</i>   | <i>1.8 to 1</i> |
|               |                                     | <i>.2 sec</i>  | <i>PDR signal present<br/>for 128 mS</i> | <i>12 dB</i>  | <i>2.9 to 1</i> |
|               |                                     | <i>5 sec</i>   | <i>PDR signal present<br/>for 10 sec</i> | <i>18 dB</i>  | <i>4.5 to 1</i> |

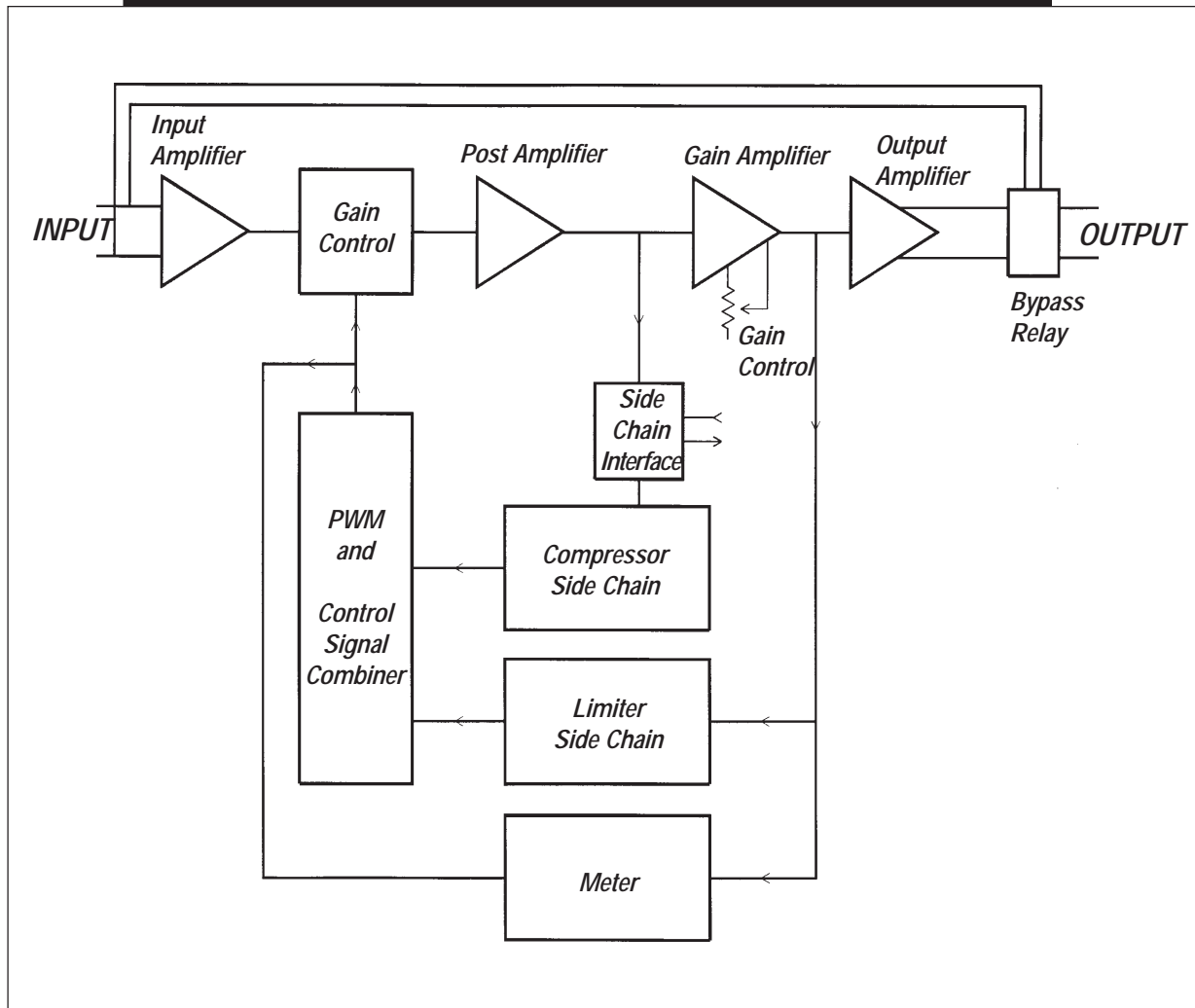
**SIGNAL FLOW BLOCK DIAGRAM (SINGLE CHANNEL)**

## INTERFACING

Input: Floating, balanced. Maximum input is +25 dBm.  
The connectors are XLR.

Output: Floating, balanced. Maximum output is +25 dBm.  
The connectors are XLR.

For *Input* and *Output*: Pin 2 is Sig + , Pin 3 is Sig- , Pin 1 is GND

Side Chain Connections: Floating, balanced. Connections are made by using a DB-15 Male Connector. This is a loop insert and must be normaled back to the STC-8.

### SIDE CHAIN CONNECTIONS/PIN OUT CHART

|                       | Channel 1 PIN# | Channel 2 PIN# |
|-----------------------|----------------|----------------|
| <i>Output: SIG+</i>   | 10             | 1              |
| <i>(send) SIG -</i>   | 11             | 9              |
| <i>GND</i>            | 14             | 2              |
| <i>Input: SIG +</i>   | 5              | 8              |
| <i>(return) SIG -</i> | 6              | 7              |
| <i>GND</i>            | 13             | 15             |

*To enable connect PIN 4 to PIN 3  
limiter preset enable PIN 12 to PIN 13*

Unbalanced Connections: Are made by tying the SIG- Pin to the GND Pin. If the connection is an input, it is best to tie at the signal source. If the connection is an output, it is best to tie at the STC-8 connector.

Power: 100, 120, 230,240 volt; 50/60 Hz; 55 watts  
MDL .6A Fuse for 100V and 120V  
MDL .3A Fuse for 230V and 240V

Pilot Lamp: # 7335

Shipping Weight: 19 lbs. (8.6 kg)

Depth Behind Panel: 12.5 inches (31.75 cm) plus cabling

Panel Height: 2 rack spaces



## SPECIFICATIONS

### Compressor

Attack Time: FAST; measured by doing 18 dB of Gain Reduction. The time to 18 dB of Gain Reduction is less than 1mS. 12 dB of the 18 are reached in .4mS.  
SLOW; for 6 dB of GainReduction, 100mS

### Compressor

Release Time: FAST; From 12 dB of Gain Reduction to No Gain Reduction. 11 of 12 dB are reached in 50mS (Non Program Dependant Release)  
SLOW; 20 sec for a full 12 dB release with PDR enabled.

### Limiter

Attack Time: less than 1uS.

### Limiter

Release Time: 60mS for 6 dB of Gain Reduction.

### Maximum

Signal Level: Input or Output, +25 dBm

### Noise Floor:

-88 dBm measured 20Hz to 20kHz

### Frequency

Response: 5Hz to 55kHz (Hara Mode)

### Limiter Slope:

Greater than 10 to 1

## LINE VOLTAGE RANGE

| Setting                   | Min. Voltage | Max. Voltage |
|---------------------------|--------------|--------------|
| 100V                      | 91V          | 112V         |
| 120V                      | 104V         | 130V         |
| 230V<br>(same as<br>220V) | 190V         | 236V         |
| 240V                      | 206V         | 257V         |

## MODE SWITCH - KI SOUND AND OPTIONS

A number of vintage compressors have a frequency response that changes with gain change. This is a result of changing circuit impedance and is typical of optical based compressors such as the LA-2A and similar devices. These devices will be flat with no gain reduction and become bright with gain reduction, or will lose hi end with no gain reduction and become flat with 6 to 12 db of gain reduction. It's part of their sound and is highly prized by many people. However it may not be what you want depending upon the application.

Part of the KI sound is similar to the above effect and part is a modification of the side chain. There is a way to change the operation of the STC-8 so that only the side chain is changed in the KI position of the mode switch. This means that the compression artifacts will become second harmonic (normal mode of KI) but the audio path will be left transparent. This is done by changing an internal jumper J3. The normal mode as shipped from the factory is with the effect enabled.

The following drawing shows the jumper location. It is located close to the center of the main circuit board next to a yellow relay. With the jumper on the front 2 pins the HF effect will take place. With the jumper on the back 2 pins the effect will not be engaged with the mode switch.

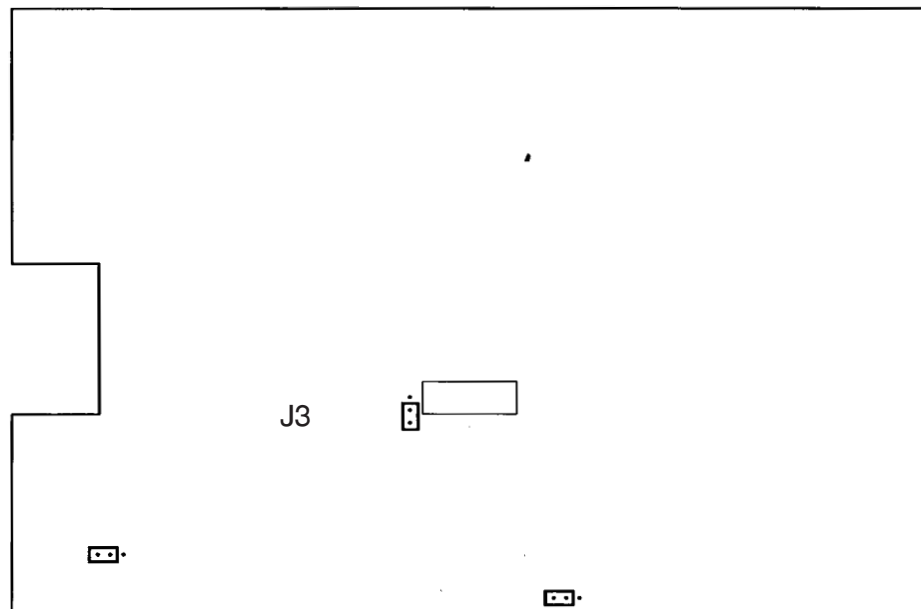

If you do this the unit **MUST BE FIRST BE DISCONNECTED FROM AC POWER, THE CORD UNPLUGGED**. You should ground your self to the unit before removing the top cover and remain in physical contact with the unit to prevent static discharge. If you are unsure get a tech. to change the jumper.

## LIMITER SOURCE

J1 and J2 determine the signal source for the peak limiter. The normal mode of operation is on the two left most pins. This is set so the limiter is referenced to the output, post gain control. It is recommended that the jumpers be left in this position. Please contact us before changing J1 and J2.





2117 E. 5th Street  
Superior, WI 54880 USA  
tel. 715-398-3627  
fax. 715-398-3279

**STC-8 DISCRETE CLASS A COMPRESSOR-LIMITER**

# REGISTRATION FORM

Please fill out this form and return it so we can send you updates and pertinent information as it becomes available.

Thank you.

NAME \_\_\_\_\_

STUDIO NAME \_\_\_\_\_

ADDRESS \_\_\_\_\_

CITY \_\_\_\_\_ STATE \_\_\_\_\_ ZIP \_\_\_\_\_

COUNTRY \_\_\_\_\_ PHONE \_\_\_\_\_

SERIAL # \_\_\_\_\_

DEALER \_\_\_\_\_

PURCHASE PRICE \_\_\_\_\_

EMAIL \_\_\_\_\_ WEBSITE \_\_\_\_\_